

Stainless steel

Toolbox 1200x600x600 SS bottom hinged, cable Tilbox, polished, 2 locks

Product code: 103908 Old product code: 70147

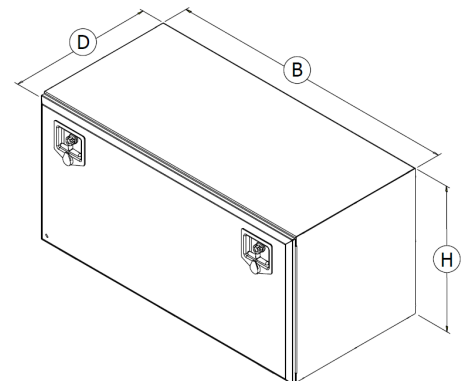

Description

Tilbox is a toolbox made entirely of stainless steel.

Durable all-welded construction. Plate thickness 1.5 mm.

Door polished.

The lock and hinges are also made of stainless steel.

Sealing around the door and a valve behind the box.

The door is equipped with an open cable. The door and box are ready for the gas spring sold as an accessory.

Weight: 40 kg**B:** 1200 mm**H:** 600 mm**D:** 600 mm

The door has a lock with two keys.

L: 1200mm

H: 600mm

D: 600mm

Additional images

